

Power Entry Module with RFI Power Line Filter for General or Medical Applications

L Series



**UL Recognized
CSA Certified
VDE Approved**



L Series

The L series power entry modules are compact units that combine a multi-function power entry module and high performance RFI filtering capabilities. They are available with either a four-voltage selector or a DPST on/off switch. Both variations can be specified with North American or European fusing capabilities and are available in either flange or snap-in mounting.

These filters are UL recognized, CSA certified, and VDE approved. The L series modules offer a choice of filters for general or medical applications.

EDL Models

The RFI filter is for general purpose applications where line-to-line and line-to-ground noise must be controlled. The filter is designed to meet the very low leakage requirements of VDE portable equipment. They are available in three current ratings.

EHL Models

This medical filter provides susceptibility protection without the leakage current associated with line-to-ground capacitors. Designed to allow equipment to meet UL544 for patient care and non-patient care equipment, the EHL filter has a maximum leakage current of 2 μ A at 120 VAC 60 Hz. See Appendix C for more information on medical applications and UL standards.

Note: When using the models with an IEC connector, remember that the leakage current of the companion line cord, GA400, is more significant than that of the filter - which may disqualify this line cord from use in patient care applications.

Voltage Selection

To change selected voltage: disconnect the power cord; open cover using a small blade screwdriver or similar tool; insert the tool into the voltage selection slot and remove wheel from unit; select desired voltage; replace wheel into unit and close cover, *making sure the selected voltage appears in connector window.*

Note: All models have North American or dual European fusing capability and are available in either flange or snap-in mounting.

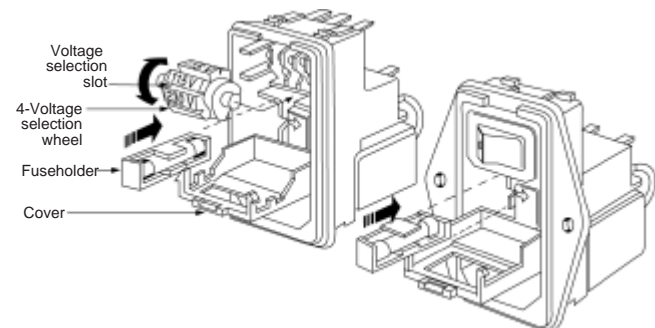

Power Entry Module with RFI Power Line Filter for General or Medical Applications (Continued)

L Series

Electrical Schematics

DL Models (with switch)

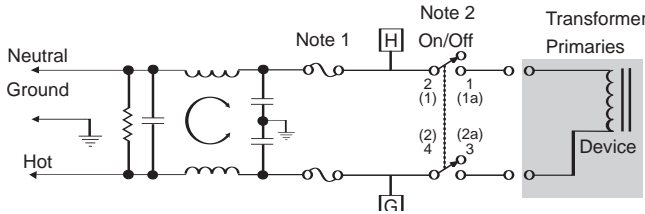

DL Models (with 4-voltage selection)

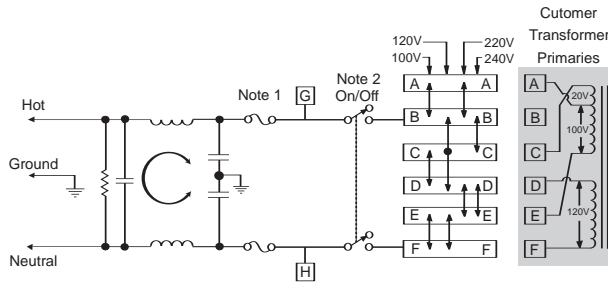

HL Models (with switch)

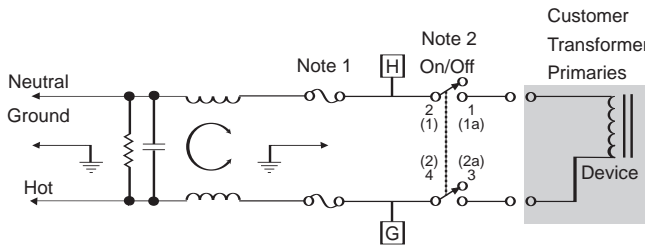

HL Models (with 4-voltage selection)

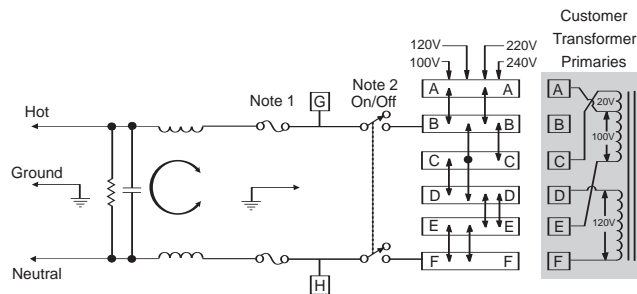

Note 1: Provision for dual European style fusing.
 Note 2: On/Off switch present only with "S" suffix.
 Resistor location for reference only.

Specifications

Maximum leakage current, each line-to-ground:

	EDL Models	EHL Models
@120 VAC 60 Hz:	0.25 mA	2 µA
@250 VAC 50 Hz:	0.50 mA	5 µA

Hipot rating (one minute):

	EDL Models	EHL Models
line-to-ground	1500	1500
line-to-line	1450	1450

Operating frequency:

50/60 Hz

Operating voltages:

1S & 1SC Suffix (fixed):	250 VAC Max.
4 & 4C Suffix (selectable):	100, 120, 220, 240 VAC

Rated current:

2EDL & 2EHL	2A
4EDL & 4EHL	4A
6EL, 6EDL & 6EHL	6A

Switch:

Double-insulated, rated for 10,000 operations at full load. 51 Amp inrush capability.

Fuse (not included):

Accepts one .25" x 1.25" fuse or two 5 x 20 mm fuses

Terminals:

110 [2.79] except for switch
 .187 [4.8] for switch

Minimum insertion loss in dB:

Line-to-ground in 50 ohm circuit

Current Rating	Frequency-MHz					
	.05	.15	1	5	10	30
EDL Models						
2A	6	14	24	40	45	50
4A	2	8	18	32	38	45
6A	1	6	17	31	37	45
EHL Models						
6A	3	8	15	18	18	18

Line-to-line in 50 ohm circuit

Current Rating	Frequency-MHz						
	.05	.5	1	3	5	10	30
EDL Models							
2A	7	16	21	23	37	47	50
4A	6	14	18	23	26	45	47
6A	6	15	20	25	24	45	50
EHL Models							
6A	4	14	20	28	32	38	42

**Power Entry Module with RFI Power Line Filter for General
or Medical Applications (Continued)**

L Series

Case Styles — Unfiltered Models

Flange Models

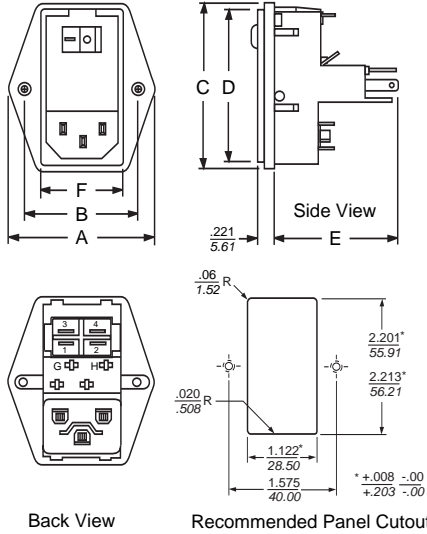

Typical dimensions:
 Mounting Holes: .126 [3.20] Dia. (2)
 All backplate terminals: .110 [2.79] terminals, except for switch.
 Switch terminals are .187 [4.765] Note: Snap-in models allow front mounting only.

Snap-In Models

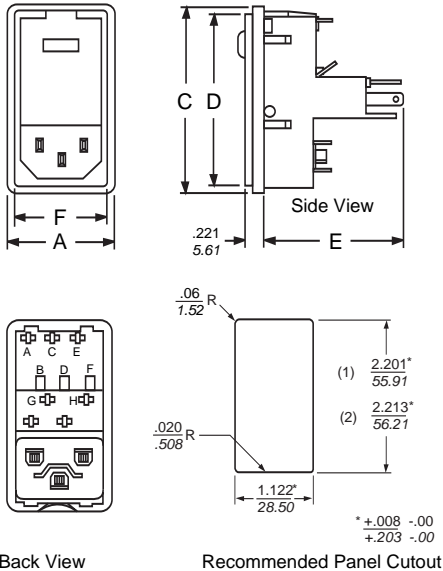

(1) For panel thickness of .031-.079 [0.8-2.0]
 (2) For panel thickness of .083-.126 [2.1-3.2]
 (3) For snap-in application, the 1.22 [28.5] sides of the cutout must have a .02 [.508] radius on the installation side.
 All backplate terminals: .110 [2.79] terminals, except for switch. Switch terminals are .187 [4.75]
 Note: Snap-in models allow front mounting only.

Case Styles — Filtered Models

Flange Models

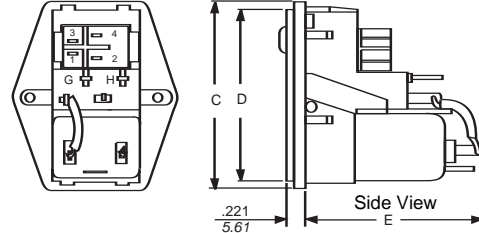

Snap-In Models

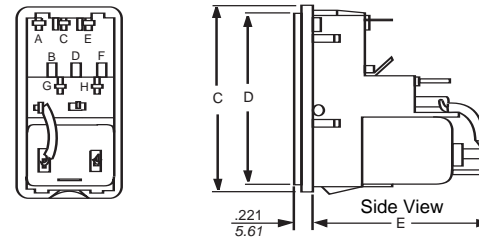

Note: Metric fuse models have additional jumper from filter-to-module.

Case Dimensions

Part No.	A (max)	B <i>±.015</i> <i>±.381</i>	C (max)	D (max)	E (max)	F (max)
Flange	1.98	1.575	2.3	2.14	1.66	1.11
Unfiltered	<i>50.29</i>	<i>40.0</i>	<i>58.42</i>	<i>54.36</i>	<i>42.16</i>	<i>28.19</i>
Snap-in	1.28	—	2.3	2.14	1.66	1.11
Unfiltered	<i>32.51</i>	—	<i>58.42</i>	<i>54.36</i>	<i>42.16</i>	<i>28.19</i>
Flange	1.98	1.575	2.3	2.14	2.01	1.11
Filtered	<i>50.29</i>	<i>40.0</i>	<i>58.42</i>	<i>54.36</i>	<i>51.05</i>	<i>28.19</i>
Snap-in	1.28	—	2.3	2.14	2.01	1.11
Filtered	<i>32.51</i>	—	<i>58.42</i>	<i>54.36</i>	<i>51.05</i>	<i>28.19</i>

Power Entry Module with RFI Power Line Filter for General
or Medical Applications (Continued)

L Series

UNFILTERED MODELS

Part Number	Current Rating	Available Voltage Selection Position	DPST On/Off Switch	Mounting Style	Fuseholder Type
6EL1S	6A	1	•	Flange	North American
6EL1SC	6A	1	•	Snap-In	North American
6EL1SM	6A	1	•	Flange	Metric
6EL1SCM	6A	1	•	Snap-In	Metric
6EL4	6A	4		Flange	North American
6EL4C	6A	4		Snap-In	North American
6EL4M	6A	4		Flange	Metric
6EL4CM	6A	4		Snap-in	Metric

FILTERED MODELS

Part Number	Filter Type	Current Rating	Available Voltage Selection Position	DPST On/Off Switch	Mounting Style	Fuseholder Type
2EDL1S	Linear	2A	1	•	Flange	North American
2EDL1SC	Linear	2A	1	•	Snap-In	North American
2EDL1SM	Linear	2A	1	•	Flange	Metric
2EDL1SCM	Linear	2A	1	•	Snap-In	Metric
2EDL4	Linear	2A	4		Flange	North American
2EDL4C	Linear	2A	4		Snap-In	North American
2EDL4M	Linear	2A	4		Flange	Metric
2EDL4CM	Linear	2A	4		Snap-in	Metric
4EDL1S	Linear	4A	1	•	Flange	North American
4EDL1SC	Linear	4A	1	•	Snap-in	North American
4EDL1SM	Linear	4A	1	•	Flange	Metric
4EDL1SCM	Linear	4A	1	•	Snap-in	Metric
4EDL4	Linear	4A	4		Flange	North American
4EDL4C	Linear	4A	4		Snap-in	North American
4EDL4M	Linear	4A	4		Flange	Metric
4EDL4CM	Linear	4A	4		Snap-in	Metric
6EDL1S	Linear	6A	1	•	Flange	North American
6EDL1SC	Linear	6	1	•	Flange	North American
6EDL1SM	Linear	6	1	•	Flange	Metric
6EDL1SCM	Linear	6	1	•	Snap-in	Metric
6EDL4	Linear	6	4		Flange	North American
6EDL4C	Linear	6	4		Snap-in	North American
6EDL4M	Linear	6	4		Flange	Metric
6EDL4CM	Linear	6	4		Snap-in	Metric
6EHL1S	Medical	6	1	•	Flange	North American
6EHL1SC	Medical	6	1	•	Snap-in	North American
6EHL1SM	Medical	6	1	•	Flange	Metric
6EHL1SCM	Medical	6	1	•	Snap-in	Metric
6EHL4	Medical	6	4		Flange	North American
6EHL4C	Medical	6	4		Snap-in	North American
6EHL4M	Medical	6	4		Flange	Metric
6EHL4CM	Medical	6	4		Snap-in	Metric

• Includes DPST switch